

Article number: 12309000025100
Description: KLEE-coil 309 000 025.100
M2,5 Unhardened steel

Measures

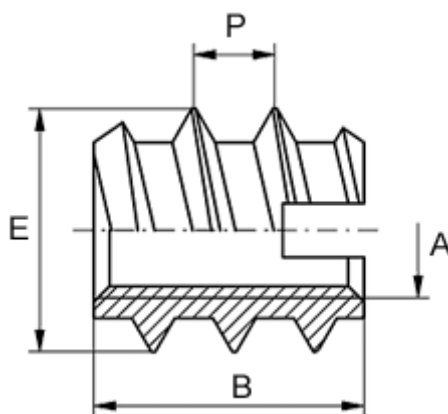

Female thread A	= M2,5
Length B	= 6
Male thread E	= 5.0
Min hole depth	= 8
Recommended bore diameter (plastic/hard wood)	= 3.6 to 3.8
Recommended bore diameter, soft wood (largest)	= 4.0
Thread pitch P	= 2.0